

CASH[®] Magnum Auto

Original Instruction Manual



©2017 Accles & Shelvoke Ltd



**DO NOT ATTEMPT TO USE THESE STUNNING TOOLS UNTIL
YOU HAVE READ AND UNDERSTOOD THE USER MANUAL**

SECTION	DESCRIPTION	PAGES
	CONTENTS	2
1	PRODUCT DESCRIPTION	3
2	PRODUCT SPECIFICATION	4
3	PRODUCT DIAGRAM	5
4	ANIMAL WELFARE	6
5	EFFECTIVE STUNNING & CARTRIDGE SELECTION	7
6	GENERAL SAFETY PRECAUTIONS	15
7	SAFE OPERATING INSTRUCTIONS	19
8	CLEANING & GENERAL MAINTENANCE	22
9	TROUBLESHOOTING	25
10	SERVICING	27
11	SPARE PARTS LIST AND DIAGRAM	28
12	CONTACT DETAILS, WARRANTY AND RECYCLING	29
	DECLARATION OF CONFORMITY CERTIFICATE	32

DISCLAIMER

This instruction manual is correct at the time of printing. However, because our policy is one of constant development and improvement, details and images may vary slightly from those provided in this publication.

© Copyright of Accles & Shelvoke Ltd 2017 - All rights reserved

“Accles & Shelvoke”, “CASH”, and “CASH Magnum Auto” are all trademarks of Accles & Shelvoke Ltd

ONLY EVER USE GENUINE ACCLES & SHELVOKE REPLACEMENT PARTS. NOT USING GENUINE PARTS MAY LEAD TO PREMATURE COMPONENT AND TOOL FAILURE, WHICH COULD ENDANGER THE OPERATOR AND THOSE IN THE IMMEDIATE VICINITY. IT WILL ALSO INVALIDATE OUR ORIGINAL EQUIPMENT WARRANTY.

ACCLES & SHELVOKE WILL ACCEPT NO LIABILITY IF ANY COMPONENTS OTHER THAN THOSE SUPPLIED BY ACCLES & SHELVOKE ARE USED WITH OUR ORIGINAL EQUIPMENT. THE RESULTANT LIABILITY WILL BE WITH THE END USER OR THE DISTRIBUTOR WHO SUPPLIED THE UNAPPROVED REPLACEMENT PARTS.

The CASH Magnum Auto range of stunners are cartridge powered, trigger operated, cylindrical style penetrative tools with automatic bolt return. They are available in .22” and .25” calibre and can be used on a range of animals from sheep and goats to heavy cattle. These tools are intended for professional use.

PRODUCT	PRODUCT CODE	PRODUCT DESCRIPTION	CALIBRE	MAXIMUM PERMITTED CARTRIDGE
CASH Magnum Auto	5652AS	CASH Magnum .22R Auto SF	0.22	4.5 GRAIN (.22 BLACK)
	5652R	CASH Magnum .22R Auto	0.22	4.5 GRAIN (.22 BLACK)
	5660	CASH Magnum .25R Auto	0.25	4.5 GRAIN (.25 GREEN)
	5660S	CASH Magnum .25R Auto SF	0.25	4.5 GRAIN (.25 GREEN)

The CASH Magnum Auto range of stunning tools are penetrative captive bolt devices which cause severe and irreversible damage to the brain. These tools are designed to stun all designated animals prior to slaughter or depopulation. They can be used in accordance with EU Council Regulation (EC) number 1099/2009 On the Protection of Animals at the Time of Killing.

SF Models 5652AS and 5660S feature a ‘stop fire’ mechanism. This is a quarter - turn operated mechanism that when the operator chooses to can set the tool in stop fire mode. In this mode the firing pin is prevented from striking the cartridge thus preventing firing of the tool rendering it safe. Please refer to section 7 for further details.

The CASH Magnum Auto range of stunners have been on the market for many years and in that time have earned a reputation for being a robust, reliable and effective tool. It can be used with a range of cartridges for different animal sizes.

To ensure the safety of the operator, and quality of products, all Accles & Shelvoke stunning tools are proof tested in accordance with the Rules of Proof 2006. We have several ‘assistant proof masters’ who are accredited by the British Proof House (formerly the Birmingham Proof House, www.gunproof.com). We work to standards set by the Commission Internationale Permanente pour l’Epreuve des Armes á Feu Portatives (CIP). All stunning tools are “Proofed” prior to the stunners being released to customers. Proofed components are stamped with the mark of the British Proof House, so that users can be assured of the quality and safety of the product.

ATTRIBUTE	STUNNER MODEL NUMBER			
	5652AS	5652R	5660	5660S
Length (mm)	370	370	370	370
Width (mm) (At Widest Point)	60	60	60	60
Weight (kg) *	2.9	2.8	2.8	2.9
'A' weighted Sound Pressure Level at workstation (dB)	87	87	87	87
'A' weighted Sound Power Level (dB)	81	81	81	81
'C' weighted Peak emissions (dB)	119	119	119	119
Calibre	.22	.22	.25	.25
Chamber	Reduced	Reduced	Reduced	Reduced
Stop Fire Mechanism	Yes	No	No	Yes

* Rounded to 1 decimal place.

Sound values determined according to EN 15895 using EN ISO 3744, using the maximum rated cartridge for a given tool. Tests conducted using simulated load (paper sheets and plasticine).

The A-weighted sound pressure level and A-weighted sound power level have been calculated – and are hence valid – at the maximum number of driving processes in one second.

The maximum number of driving processes in the CASH Magnum Auto tool is one per second. This applies to all of the tools in the range included in this instruction manual.

Information about vibrations

EN15895 states - for cartridge operated hand tools, the vibration total value to which the hand-arm system is subjected does not exceed 2.5m/s². The generated mechanical recoil that is transmitted into the hand and arm of the operator is not considered to be a vibration.

CASH MAGNUM AUTO

Fig. 3.01

©2016 Accles & Shelvoke



THE MAXIMUM GRAINS (GRN) AND SERIAL NUMBER OF THE TOOL CAN BE FOUND ENGRAVED ON THE BARREL OF THE STUNNER

*** NOTE** - Every tool in the CASH range is stamped with the maximum permitted (PROOF) cartridge, showing the maximum grains (GRN) that should be used.



DANGER ZONE!

Assuming recuperator sleeves and washers have been mistakenly omitted from the tool

4 3/4" (121MM)

NEVER POINT THE BARREL END OF THE STUNNING TOOL AT YOURSELF OR ANY OTHER PERSON

NEVER USE A MORE POWERFUL CARTRIDGE THAN THE MAXIMUM PERMITTED CARTRIDGE AS STAMPED ON YOUR STUNNING TOOL

DO NOT GRIND THE OUTSIDE DIAMETER OF THE BOLT!

POLEAXE END (OF BOLT)

Re-sharpen by re-coning using a countersink tool

Improving the protection of animals at the time of slaughter contributes to higher meat quality.

EU Only - in accordance with EU Council Regulation (EC) Number 1099/2009 on the protection of animals at the time of killing, animals must be spared any avoidable pain, distress or suffering during their killing and related operations.

Business operators shall in particular take the necessary measures to ensure that animals:

- (a) Are provided with physical comfort and protection, in particular by being kept clean, in adequate thermal conditions and prevented from falling or slipping;
- (b) Are protected from injury;
- (c) Are handled and housed taking into consideration their normal behaviour;
- (d) Do not show signs of avoidable pain or fear or exhibit abnormal behaviour;
- (e) Do not suffer from prolonged withdrawal of feed or water;
- (f) Are prevented from avoidable interaction with other animals that could harm their welfare.

In addition:

- ▶ Introduce the animal into the stun box only when the operator is ready to stun it;
- ▶ Avoid excessive light and noise at the stun box to keep animal stress to a minimum;
- ▶ The operator should not have to concentrate on keeping his balance, or have to bend excessively each time he stuns an animal, as this becomes tiring and can lead to inaccurate stunning. Stun box and race design is therefore of utmost importance for both animal welfare and the operator's health and safety;
- ▶ The efficiency of each stunner is essential to ensuring an effective stun. Ensure cleaning and maintenance schedules detailed within this Instruction Manual are adhered to;
- ▶ Ensure at least 2 stunning tools are present near the stun box. If one stunner breaks down in use, then there must be a working second tool available, to ensure there is always a means of administering an effective stun to the target animal.

NOTE - we always advise you refer to any local regulations in force.

CASH® Magnum Auto

EFFECTIVE STUNNING AND CARTRIDGE SELECTION

This section provides a guide to the correct stunning position and direction for certain animals, and helps you to select the correct cartridge for that animal. The cartridge selection information provided within this section of this instruction manual is not categorical and is hence supplied as guidance only.

GOOD PRACTISE

- ▶ Understand animal welfare - refer to the Animal Welfare section for further guidance
- ▶ Always ensure your stunning tool is in good working order
- ▶ Stunning tools should be cleaned and maintained in accordance with the instructions within this manual
- ▶ Ensure at least 2 stunning tools are present near the stun box
- ▶ Stunning tools will require more maintenance if used with cartridges that are more powerful than is necessary for the target animal

EFFECTIVE STUNNING

The cartridge selection and the blow being applied to the correct part of the skull and in the right direction is important in ensuring an effective stun. Refer to the diagrams and selection charts within this section as guidance towards selection. To obtain maximum effect, the barrel of the tool must always be held firmly against the head.

The physical signs of an effective stun are:

Quadrupeds

- ▶ Animal collapses
- ▶ No rhythmic breathing
- ▶ Fixed, glazed expression in the eyes
- ▶ No corneal reflex
- ▶ Relaxed jaw
- ▶ Tongue hanging loose

THE EFFECTIVENESS OF THE STUN MUST BE VERIFIED BEFORE THE ANIMAL IS SLAUGHTERED.

FAILURE TO STUN

If an animal is not properly stunned it must be re-stunned immediately. Using the second or an alternative stunning tool, a repeat shot must always be placed so as to avoid the immediate area of the first shot.

STUN-TO-STICK TIMES

The humane killing of livestock using captive bolt equipment is a two-stage procedure. After the animal has been stunned, it must be bled (or pithed*) immediately to ensure rapid death.

The stun-to-stick interval is the time from application of stunning equipment to the start of bleeding. After stunning, sticking should be conducted without delay with a maximum stun-to-stick interval of 15 seconds recommended for all species in the field. In the abattoir, all pigs, sheep and goats should also be stuck within 15 seconds. However, on the majority of cattle lines, where the carcass must be hoisted to a bleed area, maximum stun-to-stick intervals of 60 seconds for the penetrative captive-bolt and 30 seconds for the non-penetrative captive-bolt are acceptable. (These figures are obtained from the Humane Slaughter Association (HSA) website).

* Dependant upon localised regulations in force.

CASH® Magnum Auto
**EFFECTIVE STUNNING AND
 CARTRIDGE SELECTION**

CORRECT STUNNING POSITION

CATTLE

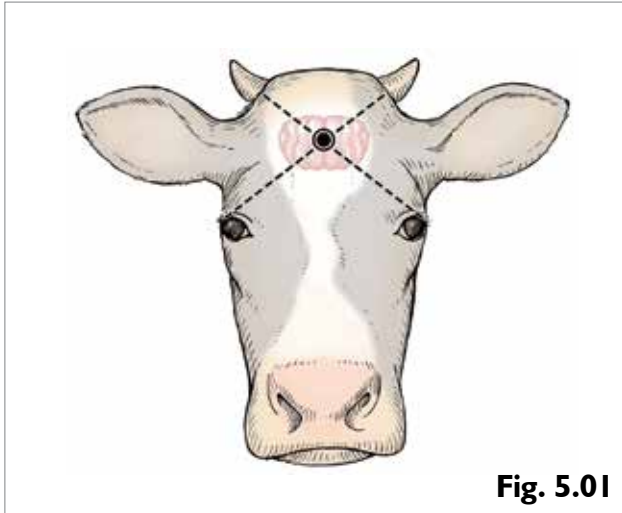

Fig. 5.01

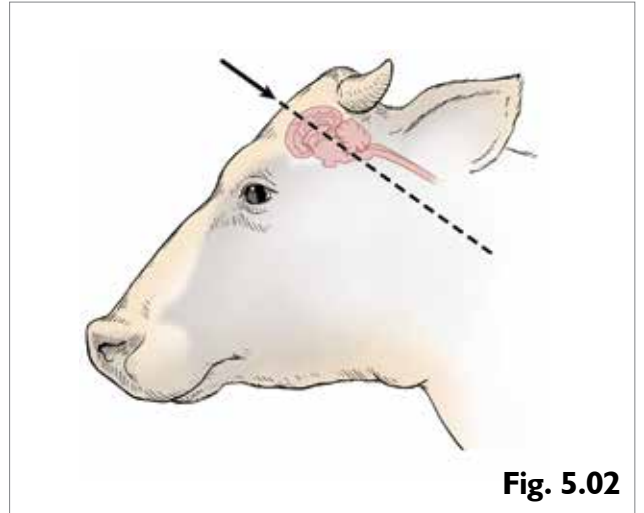

Fig. 5.02

Positioning imagery courtesy of J.K. Shearer, Iowa State University.

	SUGGESTED TOOLS AND CARTRIDGES			
	.22" RANGE		.25" RANGE	
	CASH MAGNUM .22R AUTO SF (5652AS)	CASH MAGNUM .22R AUTO (5652R)	CASH MAGNUM .25R AUTO (5660)	CASH MAGNUM .25R AUTO SF (5660S)
CALVES	PINK	PINK	PINK	PINK
LIGHT ANIMALS	PURPLE	PURPLE	YELLOW	YELLOW
MEDIUM ANIMALS	GREEN	GREEN	BLUE	BLUE
HEAVY ANIMALS & BULLS	RED	RED	ORANGE	ORANGE
VERY HEAVY ANIMALS	BLACK	BLACK	BLACK	BLACK
EXTREMELY HEAVY ANIMALS	N/S	N/S	GREEN	GREEN
FOR EXCEPTIONALLY HEAVY ANIMALS	N/S	N/S	N/S	N/S

N/S - NOT SUITABLE FOR DENOTED ANIMAL SIZE

CORRECT STUNNING POSITION

PIGS

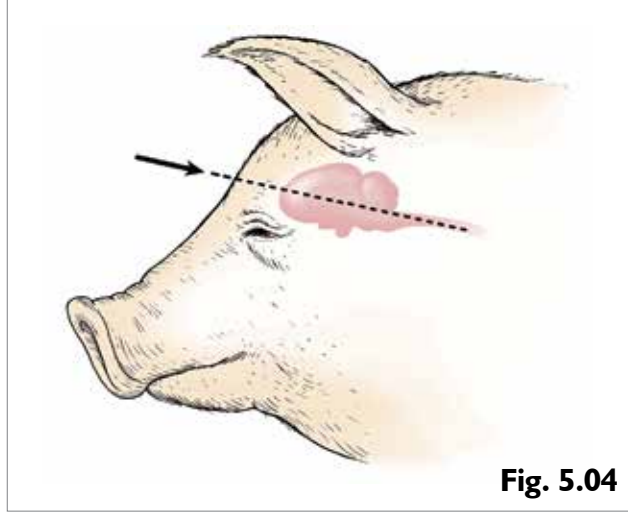
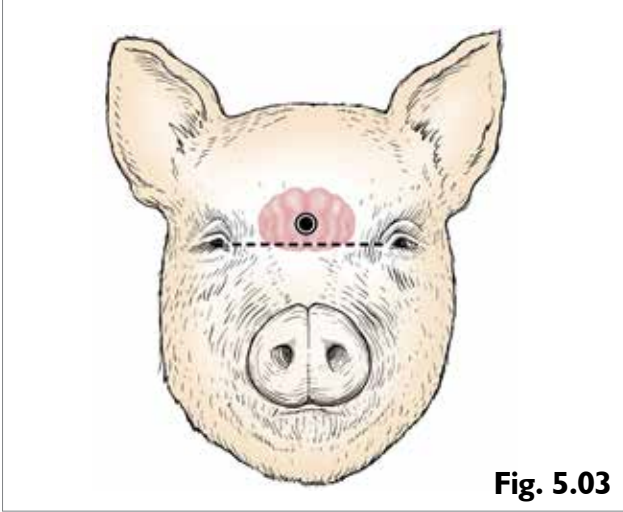

Positioning imagery courtesy of J.K. Shearer, Iowa State University.

SUGGESTED TOOLS AND CARTRIDGES

	.22" RANGE		.25" RANGE	
	CASH MAGNUM .22R AUTO SF (5652AS)	CASH MAGNUM .22R AUTO (5652R)	CASH MAGNUM .25R AUTO (5660)	CASH MAGNUM .25R AUTO SF (5660S)
FOR PIGLETS BELOW 5KG	BROWN	BROWN	PINK	PINK
FOR WEANERS & GROWERS	PINK / PURPLE	PINK / PURPLE	YELLOW	YELLOW
FOR MARKET PIGS	GREEN	GREEN	ORANGE	ORANGE
FOR HEAVY ANIMALS	RED	RED	BLACK / GREEN	BLACK / GREEN
FOR VERY HEAVY SOWS & BOARS	BLACK	BLACK	GREEN	GREEN
FOR EXCEPTIONALLY HEAVY ANIMALS	N/S	N/S	N/S	N/S

N/S - NOT SUITABLE FOR DENOTED ANIMAL SIZE

CASH® Magnum Auto
**EFFECTIVE STUNNING AND
 CARTRIDGE SELECTION**

CORRECT STUNNING POSITION

SHEEP AND GOATS

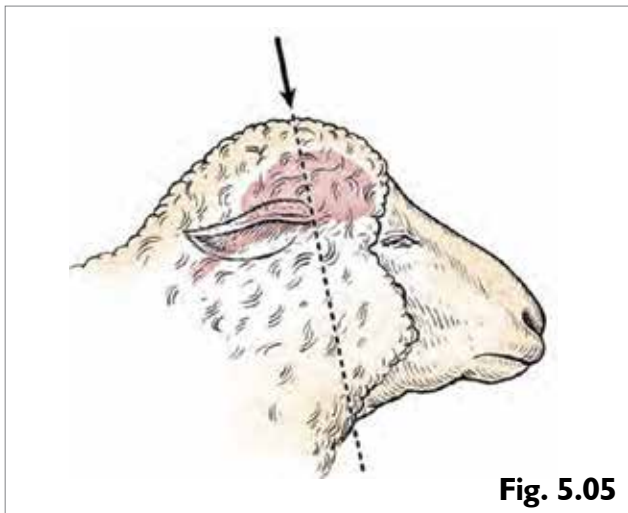

Fig. 5.05

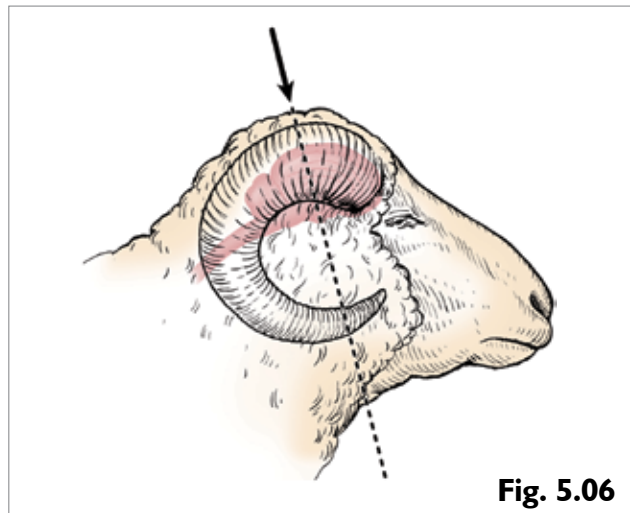

Fig. 5.06

	SUGGESTED TOOLS AND CARTRIDGES			
	.22" RANGE		.25" RANGE	
	CASH MAGNUM .22R AUTO SF (5652AS)	CASH MAGNUM .22R AUTO (5652R)	CASH MAGNUM .25R AUTO (5660)	CASH MAGNUM .25R AUTO SF (5660S)
FOR LAMBS & KIDS BELOW 5KG	BROWN	BROWN	PINK	PINK
FOR OTHER LAMBS & KIDS	PINK	PINK	PINK	PINK
FOR EWES	PINK / PURPLE	PINK / PURPLE	PINK / YELLOW	PINK / YELLOW
FOR RAMS	PURPLE	PURPLE	YELLOW	YELLOW
FOR GOATS	PURPLE	PURPLE	YELLOW	YELLOW

N/S - NOT SUITABLE FOR DENOTED ANIMAL SIZE

OTHER ANIMAL SPECIES

Although Accles & Shelvoke stunning tools are predominantly used for the stunning of cattle, sheep and pigs for meat production, we know from our 100 year history that they are also used for other animal species, such as, but not limited to:

Mammals such as:	Large fish such as:	Large reptiles such as:
Equines	Sturgeon	Alligators
Deer	Tuna	Crocodiles
Camelids	Etc	Monitor lizards
Etc		Etc

As conclusive test results are not available for these animals, we recommend you seek the advice of an independent expert to understand the appropriate cartridge selection, head placement and tool direction, prior to stunning.

ACCLES & SHELVOKE CARTRIDGE RANGE

The tables on the next page identify which cartridges from our range are suitable for use with the CASH Magnum Auto range of products. The cartridges are supplied in quantities of 50 in a metal tin, or 1000 in a box. All of our products will be clearly branded as Accles & Shelvoke CASH cartridges.

It is a condition of Accles & Shelvoke's product liability insurance that only CASH cartridges, in CASH cartons and bearing the "E" or "C" head marks, be used in stunners manufactured by Accles & Shelvoke. It follows therefore, that no liability whatsoever can be accepted for any claim, including injury, should any other brand of cartridge be used.

Where cartridges other than these are used, Accles & Shelvoke will not accept responsibility for:

- ▶ The safety of the operator
- ▶ The humaneness of the stun
- ▶ The correct operation of the stunning tool
- ▶ The premature failure of parts

Cartridges must be stored in cool, dry conditions. Exposure to excessive amounts of moisture may affect cartridge performance, which in turn will affect tool performance with the potential to create an ineffective stun of the animal.

When not in use, cartridges should be locked away separately from any stunning tools.

NOTE - "N/S" - WITH REFERENCE TO THE COMPATABILITY TABLES IN THIS SECTION OF THE MANUAL, "N/S" IDENTIFIES THAT THE CARTRIDGES HIGHLIGHTED ARE NOT SUITABLE FOR USE IN THE STATED PRODUCT IN THE TABLE.



EXCEEDING THE PERMITTED STRENGTH OF CARTRIDGE COULD BE HAZARDOUS TO THE OPERATOR, WILL REDUCE THE EXPECTED LIFE OF THE TOOL OR ITS COMPONENTS AND WILL INVALIDATE OUR WARRANTY

CASH® Magnum Auto
EFFECTIVE STUNNING AND
CARTRIDGE SELECTION

STUNNING TOOL & CARTRIDGE COMPATABILITY - .22" CALIBRE										
			1 GRAIN	1.25 GRAIN	2.25 GRAIN	3 GRAIN	4 GRAIN	4.5 GRAIN		
CALIBRE	PRODUCT CODE	DESCRIPTION	BROWN	PINK	PURPLE	GREEN	RED	BLACK		
.22"	5652AS	CASH Magnum .22R Auto SF	YES	YES	YES	YES	YES	YES	YES	
	5652R	CASH Magnum .22R Auto	YES	YES	YES	YES	YES	YES	YES	

To order your .22" calibre cartridges, please select the appropriate part number from the table below:

PART NUMBERS FOR .22" CARTRIDGES BY QUANTITY				
SIZE	COLOUR	50 IN A TIN	1000 IN A BOX	
1 GRAIN	BROWN	7505T	7505	
1.25 GRAIN	PINK	7585T	7585	
2.25 GRAIN	PURPLE	7565T	7565	
3 GRAIN	GREEN	7632T	7632	
4 GRAIN	RED	7645T	7645	
4.5 GRAIN	BLACK	7653T	7653	

CASH® Magnum Auto
EFFECTIVE STUNNING AND
CARTRIDGE SELECTION

STUNNING TOOL & CARTRIDGE COMPATABILITY - .25" CALIBRE									
			1.25 GRAIN	2 GRAIN	3 GRAIN	3.5 GRAIN	4 GRAIN	4.5 GRAIN	6 GRAIN
CALIBRE	PRODUCT CODE	DESCRIPTION	PINK	YELLOW	BLUE	ORANGE	BLACK	GREEN	RED
.25"	5660	CASH Magnum .22R Auto	YES	YES	YES	YES	YES	YES	N/S
	5660S	CASH Magnum .22R Auto SF	YES	YES	YES	YES	YES	YES	N/S

To order your .25" calibre cartridges, please select the appropriate part number from the table below:

PART NUMBERS FOR .25" CARTRIDGES BY QUANTITY				
SIZE	COLOUR	50 IN A TIN	1000 IN A BOX	
1.25 GRAIN	PINK	4121KA	7760	
2 GRAIN	YELLOW	4121KB	7710	
3 GRAIN	BLUE	4121KC	7757	
3.5 GRAIN	ORANGE	4121KD	7748	
4 GRAIN	BLACK	7754T	7754	
4.5 GRAIN	GREEN	7725T	7725	

CASH® Magnum Auto

EFFECTIVE STUNNING AND CARTRIDGE SELECTION

KEY PARAMETERS FOR CARTRIDGE SELECTION

The table on this page details the key performance parameters for the CASH Magnum Auto range of tools when used in conjunction with approved Accles & Shelvoke cartridges.

This information is issued to satisfy the requirements of EU Council Regulation (EC) Number 1099/2009 on the protection of animals at the time of killing. It provides guidelines to aid the selection of an appropriate cartridge to perform effective stunning on a particular type and size of animal. Whilst we believe this regulation is open to interpretation, these parameters have been published following years of experience.

These figures may only be used when quoted with the associated notes. Accles & Shelvoke will not accept responsibility for the reliability of these figures if used out of context.

PRODUCT CODES	CALIBRE	CARTRIDGE GRAINS (NOMINAL)	ACCLES & SHELVOKE CARTRIDGE COLOUR	BOLT DIAMETER (MM)	AVERAGE BOLT VELOCITY* (M/S)	MINIMUM BOLT EXIT LENGTH** (MM)	ENERGY GENERATED (J)
5652AS 5652R	.22"	1	BROWN	11.4	29.9	65	98
		1.25	PINK		42.7		213
		2.5	PURPLE		48.2		271
		3	GREEN		53.4		332
		4	RED		59.1		407
		4.5	BLACK		59.9		418
5660 5660S	.25"	1.25	PINK	11.4	36.6	65	156
		2	YELLOW		48.7		276
		3	BLUE		53.1		329
		3.5	ORANGE		56.6		374
		4	BLACK		64.4		483
		4.5	GREEN		67.6		533

Notes

- * When measured in air over a distance of 47mm, 15mm from the muzzle tip of the tool.
- ** When fired in air

- These quoted figures have been established during extensive testing at the Accles & Shelvoke factory test facility.

The velocity figures quoted are accurate within +/- 10%, when using a stunner that is in good condition and maintained in accordance with this instruction manual.



DO NOT ATTEMPT TO USE THIS STUNNING TOOL UNTIL YOU HAVE READ AND UNDERSTOOD THESE INSTRUCTIONS.



ALWAYS WEAR THE CORRECT PERSONAL PROTECTIVE EQUIPMENT (PPE) WHENEVER YOU ARE WORKING WITH, CLEANING OR MAINTAINING YOUR CASH MAGNUM AUTO TOOL. ALWAYS WEAR PROTECTIVE GLASSES AND HEARING PROTECTION. THE CORRECT FOOT PROTECTION MUST BE WORN. THERE IS A RISK THAT IF THE TOOL IS DROPPED, THE BOLT MAY PENETRATE THE FOOT OF THE TOOL USER.

GENERAL SAFETY STATEMENT

- ▶ THE INTENDED USE OF THIS TOOL IS FOR THE STUNNING OF ANIMALS PRIOR TO SLAUGHTER OR DEPOPULATION
- ▶ ANYONE GRANTED THE AUTHORITY TO USE ONE OF THESE TOOLS TO STUN ANIMALS SHOULD HAVE READ THIS INSTRUCTION MANUAL SUCH THAT THEY ARE MADE FULLY AWARE OF THE POTENTIAL RISKS
- ▶ THIS TOOL HAS THE POTENTIAL TO CAUSE SEVERE INJURY OR FATALITY IF USED IMPROPERLY OR INAPPROPRIATELY OUTSIDE OF ITS INTENDED SCOPE OF USE



DANGER - The hazards listed in this section pose a high level of risk which, if not avoided will result in death or serious injury

- ▶ NEVER POINT THE STUNNING TOOL AT YOURSELF OR ANY OTHER PERSON - THE BOLT WILL PENETRATE BODY PARTS AND MAY LEAD TO SEVERE AND IRREVERSIBLE DAMAGE, POSSIBLY LEADING TO FATALITY
- ▶ NEVER FIRE THE STUNNING TOOL IN AN AREA DESIGNATED AS FLAMMABLE OR CONTAINING EXPLOSIVES
- ▶ NEVER PASS THE TOOL TO ANY OTHER PERSON WHEN IT IS COCKED AND READY TO FIRE - ACCIDENTAL FIRING OF THE BOLT WILL PENETRATE BODY PARTS AND MAY LEAD TO SEVERE AND IRREVERSIBLE DAMAGE POSSIBLY LEADING TO FATALITY
- ▶ NEVER LEAVE A CARTRIDGE, WHETHER LIVE OR FIRED, IN THE BREECH - TO PREVENT ACCIDENTAL FIRING OF THE BOLT
- ▶ TOOLS SHOULD BE FIRED AS FAR AWAY FROM THE BODY AS IS COMFORTABLE AND ALWAYS POINTING AWAY FROM THE OPERATOR - FIRING OF THE BOLT TOWARD BODY PARTS MAY PENETRATE THE BODY AND MAY LEAD TO SEVERE AND IRREVERSIBLE DAMAGE, POSSIBLY LEADING TO FATALITY
- ▶ NEVER MODIFY OR CUSTOMISE THE TOOL - THIS MAY RENDER THE TOOL UNSTABLE AND UNSAFE FOR USE, WITH THE POTENTIAL TO FIRE ACCIDENTALLY. IT WILL ALSO INVALIDATE YOUR WARRANTY
- ▶ ENSURE YOU ARE BALANCED AND STABLE PRIOR TO FIRING TO AID TOOL POSITIONING ACCURACY. AVOID OVER-STRETCHING AND UNFAVOURABLE BODY POSITIONS - TO MINIMISE THE RISK OF DROPPING THE TOOL AND/OR ACCIDENTAL FIRING
- ▶ CARTRIDGE MISFIRES - IF THE CARTRIDGE HAS MISFIRED (NOT FIRED), PUT THE TOOL DOWN IMMEDIATELY AND WAIT FOR 30 SECONDS BEFORE FOLLOWING THE PROCEDURE IN SECTION 9 OF THIS MANUAL - TO AVOID DELAYED FIRING OF THE CARTRIDGE - WHICH MAY CAUSE SEVERE DAMAGE IF FIRING OCCURS WHILST BEING HANDLED
- ▶ DO NOT PLACE THE TOOL DOWN ONTO A WORK SURFACE WHEN IT IS COCKED AND READY TO FIRE – IF THE TRIGGER IS DEPRESSED WHEN PLACED DOWN, THE TOOL WILL FIRE AND THE BOLT WILL PENETRATE ADJACENT BODY PARTS



ALWAYS WEAR THE CORRECT PERSONAL PROTECTIVE EQUIPMENT (PPE) WHENEVER YOU ARE WORKING WITH, CLEANING OR MAINTAINING YOUR CASH MAGNUM AUTO TOOL. ALWAYS WEAR PROTECTIVE GLASSES AND HEARING PROTECTION. THE CORRECT FOOT PROTECTION MUST BE WORN. THERE IS A RISK THAT IF THE TOOL IS DROPPED, THE BOLT MAY PENETRATE THE FOOT OF THE TOOL USER.



DANGER - If the tool is set in the cocked (ready to fire) position and is dropped, there is a potential risk to the operator and/or people within the immediate vicinity of the dropped tool. The hazards listed in this section pose a high level of risk, which if not avoided will result in serious injury.

- ▶ IF IT DROPS AND LANDS ON THE TRIGGER, THE TOOL WILL FIRE AND THE BOLT WILL BE PROPELLED OUT OF THE TOOL AT A VERY HIGH VELOCITY. THE BOLT HAS THE POTENTIAL TO CAUSE SEVERE PENETRATIVE INJURY TO THE FEET OR LEGS IF THEY ARE WITHIN 75mm OF THE BOLT WHEN IT FIRES OUT OF THE TOOL

OUR ADVICE TO MINIMISE THE RISK:-

- ▶ IF THE TOOL IS DROPPED, LET IT FALL, DO NOT TRY TO CATCH IT
- ▶ STEP AS FAR AWAY (AS IT IS SAFE TO) FROM THE TOOL AS IT FALLS, BUT WATCH IT HIT THE FLOOR
- ▶ TAKE APPROPRIATE AVOIDABLE ACTION IF TOOL REBOUNDS
- ▶ DO NOT APPROACH THE TOOL UNTIL IT IS STATIONARY
- ▶ AFTER BEING DROPPED, CHECK THAT THE POLEAXE END OF THE BOLT IS NOT DAMAGED
- ▶ ENSURE THE TOOL IS WORKING CORRECTLY BEFORE RECOMMENCING ANY STUNNING
- ▶ IF IN DOUBT, THE TOOL SHOULD BE CHECKED AND REPAIRED AS NECESSARY



WARNING - The hazards listed in this section pose a medium level of risk which, if not avoided may result in recoverable injury

- ▶ DO NOT FIRE THE BOLT INTO HARD, BRITTLE OR IMPENETRABLE MATERIALS - AS THE BOLT MAY FRAGMENT AND POSE A DANGER OF FLYING PARTICLES
- ▶ NEVER USE A MORE POWERFUL CARTRIDGE THAN THE MAXIMUM PERMITTED CARTRIDGE AS STAMPED ON YOUR STUNNING TOOL - TO PREVENT CARTRIDGE BURST AND EXCESSIVE NOISE IN OPERATION
- ▶ KEEP THE TOOL DRY AND CLEAN - TO ENSURE YOU HAVE AN ADEQUATE GRIP ON THE TOOL DURING USE AND MINIMISE THE RISK OF DROPPING THE TOOL
- ▶ WHEN PLACING THE ASSEMBLED TOOL – OR IF THE TOOL HAS BEEN SEPARATED THE CAP OR BARREL (REFER TO FIG 3.01) – DOWN ONTO A WORK SURFACE ENSURE THERE IS A MEANS TO PREVENT THE TOOL OR TOOL PARTS FROM ROLLING OFF THE WORK SURFACE. IF THE TOOL FALLS OR DROPS FROM THE WORK SURFACE, IT MAY DROP ONTO THE FOOT OF THE OPERATOR OR OTHER PEOPLE IN THE VICINITY.



CAUTION - The hazards listed in this section pose a low level of risk which, if not avoided may result in minor or moderate injury

- ▶ KEEP FINGERS AWAY FROM BENEATH THE FIRING PIN PULL WHEN THE TOOL IS COCKED AND READY TO FIRE TO PREVENT TRAPPING.



ALWAYS WEAR THE CORRECT PERSONAL PROTECTIVE EQUIPMENT (PPE) WHENEVER YOU ARE WORKING WITH, CLEANING OR MAINTAINING YOUR CASH MAGNUM AUTO TOOL. ALWAYS WEAR PROTECTIVE GLASSES AND HEARING PROTECTION. THE CORRECT FOOT PROTECTION MUST BE WORN. THERE IS A RISK THAT IF THE TOOL IS DROPPED, THE BOLT MAY PENETRATE THE FOOT OF THE TOOL USER.



NEVER HANDLE OR OPERATE ANY STUNNING EQUIPMENT WHILST UNDER THE INFLUENCE OF ALCOHOL OR DRUGS. IF TAKING PRESCRIBED MEDICATION, SEEK THE ADVICE OF YOUR DOCTOR PRIOR TO HANDLING OR OPERATING STUNNING EQUIPMENT.

GENERAL PRECAUTIONS AND GOOD PRACTISE

IMPROPER USE

- ▶ ONLY EVER USE THIS TOOL FOR THE STUNNING OF LIVE ANIMALS
- ▶ ONLY EVER USE GENUINE ACCLES & SHELVOKE SUPPLIED CARTRIDGES AND SPARES
- ▶ DO NOT FIRE “AIR SHOTS”(FIRING OF THE BOLT INTO AIR) AS THIS WILL REDUCE THE WORKING LIFE OF THE TOOL AND ITS COMPONENTS

WORKPLACE PRECAUTIONS

- ▶ THE TOOL SHOULD BE USED IN WELL ILLUMINATED AND WELL VENTILATED WORKPLACE ENVIRONMENTS
- ▶ KEEP THE WORKPLACE CLEAN AND CLEAR OF UNNECESSARY OBSTACLES OR TRIP HAZARDS
- ▶ ENSURE THE AREA SURROUNDING THE STUN BOX IS FREE OF SLIPPERY SUBSTANCES. THESE ARE POTENTIAL SLIP HAZARDS TO THE OPERATOR WHICH COULD LEAD TO SERIOUS INJURY OR FATALITY IF THE OPERATOR SLIPS WHILST HOLDING A COCKED TOOL

OPERATIONAL PRECAUTIONS

- ▶ ONLY LOAD CARTRIDGES WHEN THEY ARE READY TO BE USED
- ▶ IF A CARTRIDGE STICKS IN THE BREECH AND WILL NOT EJECT, DO NOT USE A SHARP INSTRUMENT TO REMOVE. THE CARTRIDGE SHOULD BE REMOVED IN ACCORDANCE WITH THESE INSTRUCTIONS IN SECTION 9 - TROUBLESHOOTING
- ▶ TOOLS MAY BE USED IN AN ALTERNATING SYSTEM AS PART OF A PLANNED OPERATING CYCLE
- ▶ JOB ROTATION MAY HELP MAINTAIN THE APPROPRIATE HIGH LEVELS OF CONCENTRATION REQUIRED AT THE WORKPLACE, HELPING TO MINIMISE ANY RISK DUE TO TIREDNESS OR FATIGUE

GOOD PRACTISE

- ▶ THE CLEANING AND MAINTENANCE SCHEDULE DETAILED IN THIS MANUAL SHOULD BE ADHERED TO, TO ENSURE THE TOOL OPERATES SAFELY AND CORRECTLY TO PROVIDE EFFECTIVE ANIMAL STUNNING
- ▶ AT THE END OF A WORKING SHIFT, OR IF THE TOOL IS NOT GOING TO BE USED FOR PROLONGED PERIODS, THE UNCOCKED AND UNLOADED TOOL SHOULD BE STORED IN COOL DRY CONDITIONS AND LOCKED SECURELY IN A WAY THAT NO UNAUTHORISED ACCESS TO THE TOOL IS POSSIBLE
- ▶ CARTRIDGES SHOULD BE LOCKED AWAY SEPARATELY FROM THE STUNNING TOOL IN COOL, DRY CONDITIONS
- ▶ EXPOSURE TO EXCESSIVE AMOUNTS OF MOISTURE MAY AFFECT CARTRIDGE PERFORMANCE WHICH IN TURN WILL AFFECT TOOL PERFORMANCE, WITH THE POTENTIAL TO CREATE AN INEFFECTIVE STUN OF THE ANIMAL. WET CARTRIDGES WILL NOT FIRE AND SHOULD NOT BE USED
- ▶ ALWAYS WASH YOUR HANDS AFTER USING ANY STUNNING TOOL TO ENSURE CLEANLINESS



ALWAYS WEAR THE CORRECT PERSONAL PROTECTIVE EQUIPMENT (PPE) WHENEVER YOU ARE WORKING WITH, CLEANING OR MAINTAINING YOUR CASH MAGNUM AUTO TOOL. ALWAYS WEAR PROTECTIVE GLASSES AND HEARING PROTECTION. THE CORRECT FOOT PROTECTION MUST BE WORN. THERE IS A RISK THAT IF THE TOOL IS DROPPED, THE BOLT MAY PENETRATE THE FOOT OF THE TOOL USER.

TRANSPORTATION OF STUNNING TOOLS AND CARTRIDGES BETWEEN SITES

THIS TOOL HAS BEEN SUPPLIED TO YOU WITH THE INTENTION OF SINGLE SITE USE - SUPPLIED WITHOUT A LOCKABLE STORAGE CONTAINER. SHOULD THERE BE A NEED TO TRANSPORT THIS TOOL AND LIVE CARTRIDGES BY ROAD BETWEEN SITES, WE ADVISE:-

- ▶ PRIOR TO TRANSPORTATION, YOU SHOULD SEEK THE APPROPRIATE ADVICE CONCERNING APPLICABLE LOCAL LAWS AND REGULATIONS IN FORCE ON THE TRANSPORTATION OF CARTRIDGES TO BE USED FOR ANIMAL STUNNING
- ▶ THE TOOL AND CARTRIDGES ARE TRANSPORTED IN SEPARATE LOCKABLE CONTAINERS
- ▶ THEY ARE HIDDEN FROM PUBLIC VIEW, ie NO-ONE OUTSIDE OF THE VEHICLE CAN SEE THE LOCKABLE CONTAINERS WITHIN THE VEHICLE.

CASH® Magnum Auto SAFE OPERATING INSTRUCTIONS

 DO NOT ATTEMPT TO USE THIS STUNNING TOOL UNTIL YOU HAVE READ AND UNDERSTOOD THESE INSTRUCTIONS.



ALWAYS WEAR THE CORRECT PERSONAL PROTECTIVE EQUIPMENT (PPE) WHENEVER YOU ARE WORKING WITH, CLEANING OR MAINTAINING YOUR CASH MAGNUM AUTO TOOL. ALWAYS WEAR PROTECTIVE GLASSES AND HEARING PROTECTION. THE CORRECT FOOT PROTECTION MUST BE WORN. THERE IS A RISK THAT IF THE TOOL IS DROPPED, THE BOLT MAY PENETRATE THE FOOT OF THE TOOL USER.

 WHEN PLACING THE ASSEMBLED TOOL – OR IF THE TOOL HAS BEEN SEPARATED THE CAP OR BARREL (REFER TO FIG 3.01) – DOWN ONTO A STORAGE SURFACE ENSURE THERE IS A MEANS TO PREVENT THE TOOL OR TOOL PARTS FROM ROLLING OFF THE STORAGE SURFACE. IF THE TOOL FALLS OR DROPS FROM THE STORAGE SURFACE, IT MAY DROP ONTO THE FOOT OF THE OPERATOR OR OTHER PEOPLE IN THE VICINITY.

 ALWAYS POINT THE TOOL AWAY FROM YOUR BODY AND AWAY FROM ANY OTHER PERSON IN THE VICINITY WHEN HANDLING OR OPERATING THE TOOL

NOTE

- ▶ The maximum recommended usage rate for a CASH Magnum Auto tool is 60 shots per hour using the maximum specified cartridge

1 PREPARING FOR LOADING

- 1.1 Turn the breech cap counter clockwise and pull away. (See Fig 7.01)
- 1.2 Make sure firing pin and trigger are uncocked. (See Fig 7.02)
- 1.3 If spent (fired) cartridge is in the chamber, pull extractor up and then push back down.
- 1.4 The partially lifted case can then be removed.

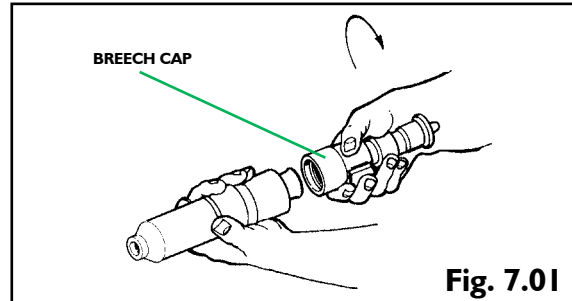

Fig. 7.01

©2016 Accles & Shelvoke

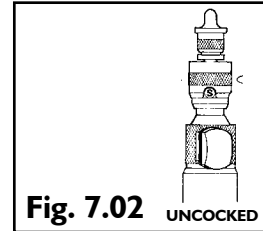

Fig. 7.02 UNCOCKED

©2016 Accles & Shelvoke

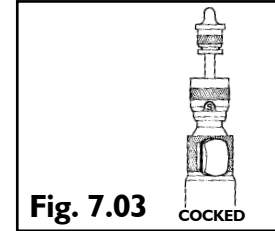

Fig. 7.03 COCKED

©2016 Accles & Shelvoke

2 LOADING

- 2.1 Before inserting the cartridge into the chamber of the breech, ensure that the bolt is fully retracted. If not, do not use the tool as the stunning power will be reduced which can lead to an ineffective stun. (See Fig 7.05)
- 2.2 Obtain a single cartridge, and load the cartridge into the cartridge chamber crimped end first. (See Fig 7.06)

NOTE

- ▶ Only load the cartridge immediately before firing
- ▶ Keep the cartridge clean and dry before insertion into the chamber
- ▶ Visually check that the bolt is fully retracted before firing (refer to Fig 7.05)
- ▶ Only use the correct grade of CASH cartridge bearing the "E" or "C" headmark, as shown in Fig 7.04
- ▶ When not in use, never leave a cartridge in the chamber, whether live or spent
- ▶ Never leave a loaded stunner unattended

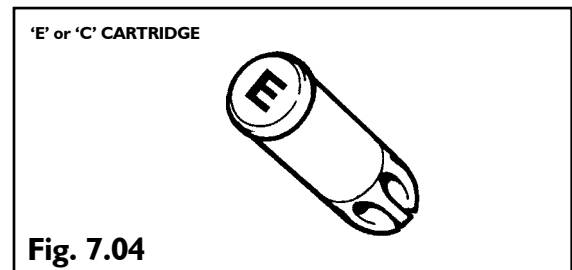

Fig. 7.04

©2016 Accles & Shelvoke

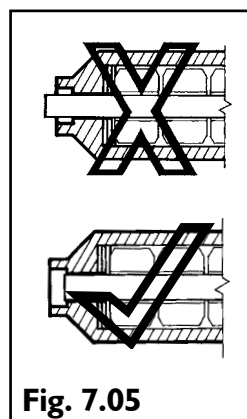

Fig. 7.05

©2016 Accles & Shelvoke

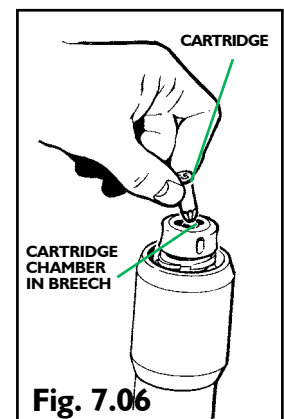

Fig. 7.06

©2016 Accles & Shelvoke

CASH® Magnum Auto SAFE OPERATING INSTRUCTIONS



ALWAYS POINT THE TOOL AWAY FROM YOUR BODY AND AWAY FROM ANY OTHER PERSON IN THE VICINITY WHEN HANDLING OR OPERATING THE TOOL

3 MAKE READY FOR FIRING

- 3.1 With the tool facing away from you, align the breech to the barrel and screw the breech cap clockwise until securely fastened
- 3.2 With the tool facing away from you, pull the firing pin pull upwards until there is a “CLICK”, the tool is now cocked and ready to fire. (See Fig 7.07)

NOTE

- ▶ Do not point the tool at yourself or any other persons
- ▶ Keep your fingers clear of and away from the trigger when loading the cartridge
- ▶ Do not place the tool down when it is cocked and ready to fire

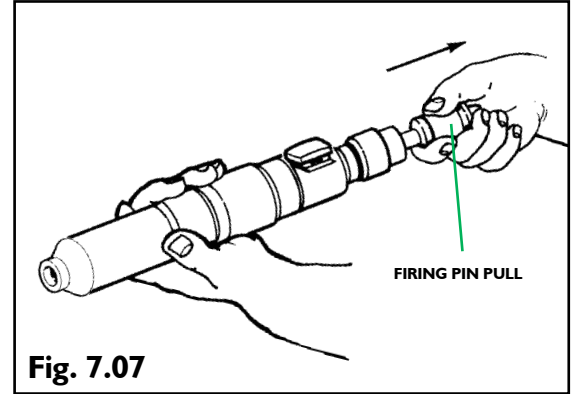

Fig. 7.07

©2016 Accles & Shelvoke

4 FIRE

- 4.1 Position the barrel tip into the correct position on the target animal's head, when it touches, you should instantaneously fire the tool by depressing the trigger to stun the animal

NOTE

- ▶ Refer to Section 5 – Effective Stunning and Cartridge Selection for the correct angle and position for the target animal
- ▶ Do not attempt to **FIRE** if the animal is moving its head
- ▶ The barrel application must be smooth and accurate and the tool fired the instant it is in position on the target area of the head
- ▶ If the shot is aborted - before depressing the trigger, unscrew the cap and remove the cartridge to make safe

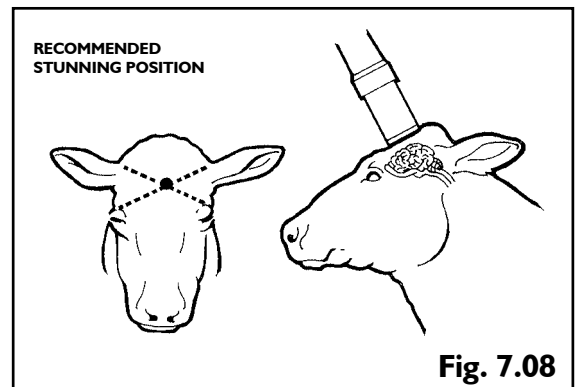

Fig. 7.08

©2016 Accles & Shelvoke

CASH® Magnum Auto SAFE OPERATING INSTRUCTIONS



ALWAYS POINT THE TOOL AWAY FROM YOUR BODY AND AWAY FROM ANY OTHER PERSON IN THE VICINITY WHEN HANDLING OR OPERATING THE TOOL

5 EXTRACTION

- 5.1 Turn the breech cap counter-clockwise and pull away
- 5.2 Pull the extractor up and then push back down (See Fig 7.09)
- 5.3 Remove the cartridge from the chamber
- 5.4 The tool is now ready for the next cartridge



IF THE CARTRIDGE HAS MISFIRED (NOT FIRED), PUT THE TOOL DOWN IMMEDIATELY AND WAIT FOR 30 SECONDS BEFORE FOLLOWING THE PROCEDURE IN SECTION 9 OF THIS MANUAL

NOTE

- ▶ The spent cartridge will be partially lifted by the extractor to make removal easier
- ▶ If the spent cartridge is stuck in the chamber, follow the procedure in Section 9 of this manual to remove safely
- ▶ Do not use a sharp implement to remove stuck cartridges as this may damage the breech or extractor

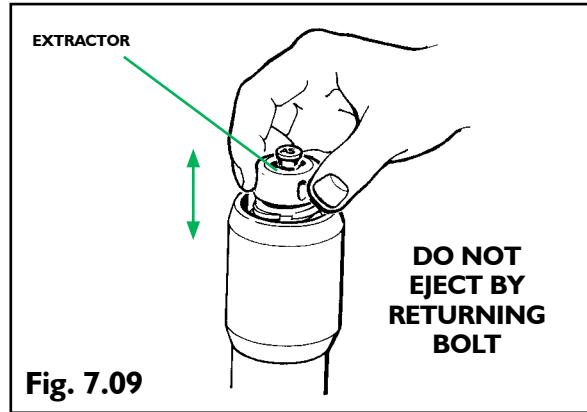

Fig. 7.09

©2016 Accles & Shelvoke

STOP FIRE MECHANISM - How to use and set your tool into safe mode - tool will not fire.

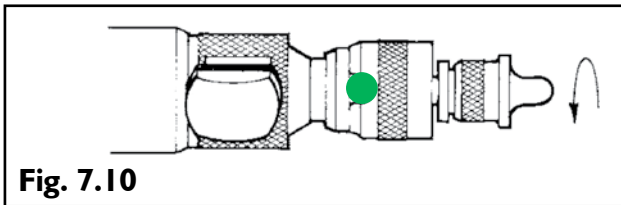

Fig. 7.10

©2016 Accles & Shelvoke

'GREEN DOT' - STOP FIRE MODE

Turn Stop Fire cap (Item 14 in Spares List and Diagram in Section 11 of this instruction manual) counter clockwise and the 'GREEN DOT' can be seen in the cut-out.

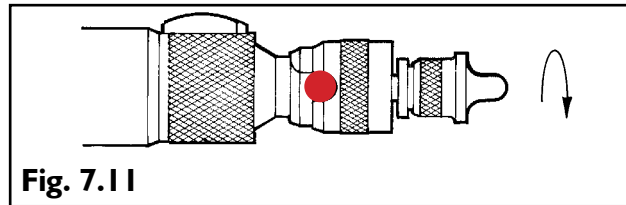

Fig. 7.11

©2016 Accles & Shelvoke

'RED DOT' - FIRE MODE

Turn Stop Fire cap (Item 14 in Spares List and Diagram in Section 11 of this instruction manual) clockwise until it stops turning and the 'RED DOT' can be seen in the cut-out.

CASH® Magnum Auto CLEANING & GENERAL MAINTENANCE



DO NOT ATTEMPT TO USE THIS STUNNING TOOL UNTIL YOU HAVE READ AND UNDERSTOOD THESE INSTRUCTIONS.



ALWAYS WEAR THE CORRECT PERSONAL PROTECTIVE EQUIPMENT (PPE) WHENEVER YOU ARE WORKING WITH, CLEANING OR MAINTAINING YOUR CASH MAGNUM AUTO TOOL. ALWAYS WEAR PROTECTIVE GLASSES AND HEARING PROTECTION. THE CORRECT FOOT PROTECTION MUST BE WORN. THERE IS A RISK THAT IF THE TOOL IS DROPPED, THE BOLT MAY PENETRATE THE FOOT OF THE TOOL USER.

PART NO.	DESCRIPTION	QUANTITY PER SET
5644	CLEANER ASSEMBLY (includes 5645, 5646 and 5647)	1
5645	STEEL CLEANER BRUSH	1
5646	BRASS CLEANER BRUSH	1
5647	CLEANER HANDLE	1
5900	HANDLE	1
5901	CHAMBER BRUSH (.22) #	1
5903	WOOL MOP (.22) #	1
5902	CHAMBER BRUSH (.25) #	1
5904	WOOL MOP (.25) #	1
4187	** CASH PISTOL OIL	1
4192	** COPASLIP THREAD GREASE	1
6076	** YOUNGS 303 FLUID	1

TABLE NOTES

** Product Data Sheets available upon request

Brush and Mop supplied in accordance with the calibre of tool

Items highlighted above are included with every CASH Magnum Auto.

The non-highlighted items are available as maintenance spares.

MAINTENANCE AND CLEANING RECORD

It is good practise and a requirement of EU COUNCIL REGULATION (EC) No 1099/2009 - On the protection of animals at the time of killing, that all stunning equipment is maintained in accordance with the manufacturers' instructions and that a log detailing the maintenance is recorded and available for external auditing purposes.

We recommend you create a maintenance and cleaning record for each individual stunning tool, containing as a minimum the following information

- ▶ Stunner product code and description
- ▶ Serial number
- ▶ Service start date (date tool was first used)
- ▶ Cleaning dates - both daily and weekly (in accordance with the cleaning stated in this instruction manual)
- ▶ Part replacement details - part number and description - date replacement/maintenance took place
- ▶ Stun Check record - Univeral Stun Check unit serial number, date checked, cartridge colour used, pass or fail
- ▶ Shots fired - total number of shots fired with the tool on a daily or weekly basis
- ▶ Name and position of person conducting the cleaning or maintenance on any given day

ONLY EVER USE GENUINE ACCLES & SHELVOKE REPLACEMENT PARTS. NOT USING GENUINE PARTS MAY LEAD TO PREMATURE COMPONENT AND TOOL FAILURE, WHICH COULD ENDANGER THE OPERATOR AND THOSE IN THE IMMEDIATE VICINITY. IT WILL ALSO INVALIDATE OUR ORIGINAL EQUIPMENT WARRANTY.

ACCLES & SHELVOKE WILL ACCEPT NO LIABILITY IF ANY COMPONENTS OTHER THAN THOSE SUPPLIED BY ACCLES & SHELVOKE ARE USED WITH OUR ORIGINAL EQUIPMENT. THE RESULTANT LIABILITY WILL BE WITH THE END USER OR THE DISTRIBUTOR WHO SUPPLIED THE UNAPPROVED REPLACEMENT PARTS.



ALWAYS POINT THE TOOL AWAY FROM YOUR BODY AND AWAY FROM ANY OTHER PERSON IN THE VICINITY WHEN HANDLING OR OPERATING THE TOOL

CLEANING DAILY - CASH Magnum Auto

- 1 Unscrew breech cap (Item 6) from breech (Item 5) and ensure that stunner is not loaded..
- 2 Unscrew breech anti-clockwise and remove from barrel (Item 1).
- 3 Withdraw bolt (Item 4) complete with washers (Items 2&7) and recuperator sleeves (Item 3) from the barrel. **NOTE!** The stop washers and some recuperator sleeves may have been retained in the barrel - ensure to **REMOVE** before cleaning.
- 4 Clean inside of barrel and breech including undercut in breech with a cloth soaked in pistol oil and followed with the steel brush end of cleaning tool.
- 5 Wipe the barrel and breech out with a clean cloth.
- 6 Remove the washers and recuperator sleeves from bolt and wire wheel or brush powder residue from piston end of bolt - wipe with cloth when clean. Wipe any residue from recuperator sleeves and washers and examine for wear.

6.1 Stop washer - Red Colour (Item 2) - There are three of these washers at the poleaxe (front) end of the bolt, which fit against the front internal end of the barrel. They protect the recuperator sleeves and as soon as they show signs of wear on either the inside or outside diameter, they should be replaced.

6.2 Flange Washer - Blue Colour (Item 7) - This washer is placed behind the last recuperator sleeve against the bolt flange. As soon as the washer shows signs of wear on the outside edge, it should be replaced.



DO NOT NEGLECT THE WASHERS OR SLEEVES. TOOL PERFORMANCE WILL BE DIMINISHED IF THESE PARTS ARE NOT IN GOOD CONDITION

6.3 Recuperator sleeves (Item 3) - A full set comprises eight sleeves. Number 1 and 8 on the bolt will be the first to show signs of wear. They should be repositioned into a middle position. Once they become badly worn and start to fray, they should be replaced.

- 7 Chamber Cleaning - Assemble the chamber brush shown in Fig. 8.01 and the chamber mop shown in Fig. 8.02 to the brush and mop handle Fig 8.03, screwing together hand tight. Using the brush end, insert via the open barrel end, into the cartridge chamber, and with a turning action, push in and out of the chamber to remove all powder residue. Youngs 303 fluid can be used if the powder is difficult to remove. Apply some pistol oil to the mop head. Insert via the open barrel end into the cartridge chamber, and with a turning action, push in and out of the chamber to remove any remaining residue or powder.
- 8 Clean the inside of the breech cap with a cloth soaked in pistol oil and then wipe dry with a clean cloth.



Fig. 8.01

©2016 Accles & Shelvoke



Fig. 8.02

©2016 Accles & Shelvoke



Fig. 8.03

©2016 Accles & Shelvoke

CASH® Magnum Auto CLEANING & GENERAL MAINTENANCE



ALWAYS POINT THE TOOL AWAY FROM YOUR BODY AND AWAY FROM ANY OTHER PERSON IN THE VICINITY WHEN HANDLING OR OPERATING THE TOOL

CLEANING WEEKLY - CASH Magnum Auto

ADDITIONAL CLEANING AND MAINTENANCE FREQUENCY DEPENDING ON USE, BUT MINIMUM WEEKLY

- 1** Remove breech cover (Item 26) and replace if worn or split. Note, if breech cover is ballooned out or cracked, replace before further use. When re-fitting the breech cover, use lubrication to assist with sliding it back on to the breech. Ensure the cover is pushed on until the inner flange touches the mating shoulder on the breech.
- 2** Remove extractor (Item 20) for cleaning by depressing the extractor plunger (Item 18) and sliding the extractor over the plunger. The area under the extractor as well as the breech threads should be cleaned with the brass brush end of the cleaner assembly.
- 3** To dis-assemble breech cap (Item 6) for cleaning or part replacement, hold in soft jawed vice and unscrew spring cap (Item 27) or the Stop Fire Assembly (Item 15A), if fitted, using a wrench on the flats. Pull firing pin assembly out of breech cap, which will also release trigger and trigger spring. Inspect firing pin (Item 16) for rounded edges from trigger contact and replace if wear is half of trigger contact. Inspect firing pin spring (Item 10) and replace if broken or collapsed. Inspect trigger (Item 17) for firing pin contact wear and replace if rounding is half of firing pin contact. Replace trigger spring (Item 9) if collapsed. Trigger spring must be strong enough to push firing pin away from cartridge and to allow trigger to lift. In order to replace firing pin, firing pin spring or spring cap or Stop Fire Assembly, unscrew pull (Item 11) from pull bush (Item 22), push pull bush down to release pull split bush (Item 23), allowing all components to slide off. Rubber pull spring (Item 25) should be replaced if collapsed or damaged. Re-assembly: wipe all steel parts with a cloth soaked in pistol oil. Do not put oil in cartridge chamber, as this can cause misfiring.



ONLY PERSONNEL WHO HAVE BEEN AUTHORISED TO DO SO SHOULD CONDUCT ANY RECTIFICATION IDENTIFIED IN THIS TROUBLESHOOTING SECTION



ALWAYS WEAR THE CORRECT PERSONAL PROTECTIVE EQUIPMENT (PPE) WHENEVER YOU ARE WORKING WITH, CLEANING OR MAINTAINING YOUR CASH MAGNUM AUTO TOOL. ALWAYS WEAR PROTECTIVE GLASSES AND HEARING PROTECTION. THE CORRECT FOOT PROTECTION MUST BE WORN. THERE IS A RISK THAT IF THE TOOL IS DROPPED, THE BOLT MAY PENETRATE THE FOOT OF THE TOOL USER.

SYMPTOMS

CAUSES

ACTION

Cartridge misfires

Firing pin failing to make contact with cartridge

If no indent is visible on the cartridge head, refer to corrective procedure on the next page

Water or oil-contaminated cartridges

Use a new box of cartridges

Oil in cartridge chamber

Remove oil and clean the chamber

Bolt does not return fully into the barrel

Incomplete set of recuperator sleeves and washers

Check and make good, as necessary

Worn washers and recuperator sleeves

Check and replace as necessary

Build-up of carbon deposits on piston, breech and in chamber

Check and remove by cleaning as instructed in 'Section 8 - Cleaning and General Maintenance'

Bolt is bent

Replace immediately

Stunner fires, but there is insufficient power to stun the animal (refer to 'Section 5 - Effective Stunning and Cartridge Selection', in this manual, for the physical signs of an effective stun)

Corrosion inside barrel

Check and remove if present

Incorrect strength of cartridge being used

Check type of cartridge against product code of stunner and animals being stunned by referring to 'Section 5' in this manual

Incorrect positioning of stunner on animal

Check correct stunning position for type of animal being stunned by referring to 'Section 5' in this manual

Bolt not returning fully to the breech after each shot

Check for carbon deposits on bolt, breech or in chamber and remove by cleaning as instructed in 'Section 8' of this manual

Check recuperator sleeves, washers and collars for wear and replace as necessary

Check number of washers, recuperator sleeves and collars, make good as necessary

Bolt sticks in animal's head

Bolt is bent

Replace immediately

Excessive build up of dirt in tool

Conduct cleaning as instructed in 'Section 8 - Cleaning and General Maintenance' of this manual

Recuperator sleeves excessively worn or missing

Check and replace as necessary

Cutting edge of bolt narrower than shaft due to incorrect sharpening

Replace bolt and sharpen by grinding the inside diameter only

Cartridge stuck or difficult to extract

Split cartridge or damaged cartridge chamber

Return tool to maintenance department for removal and repair

Refer to corrective procedure on next page

Cartridge chamber not clean

Refer to 'Section 8 - Cleaning and General Maintenance' for chamber cleaning instructions

Unusually loud noise when fired

Split cartridge

Check for damaged cartridge chamber / breech, return to manufacturer for repair

Check that the correct cartridge is being used



ALWAYS POINT THE TOOL AWAY FROM YOUR BODY AND AWAY FROM ANY OTHER PERSON IN THE VICINITY WHEN HANDLING OR OPERATING THE TOOL

SAFE MISFIRE REMOVAL

If the cartridge does not fire, follow the procedure below

- 1 Holding the tool with the barrel pointing away from you or any other person, do nothing and wait for at least 30 seconds before continuing
- 2 Turn the breech cap (Item 6) counter-clockwise and unscrew until the breech cap and barrel (Item 1) are separate
- 3 Observe if the cartridge is wet, oily or dirty
- 4 Look at the cartridge head - if it has been struck, drop the cartridge into a water-filled metal container to make safe;
- 5 If there is no indent, follow the corrective procedure below
- 6 Clean the cartridge chamber using chamber brush and mop and a soft cloth before testing with a new cartridge
- 7 If the tool misfires a second time, remove it from the work area as it requires further investigative work and servicing

MISFIRE - CORRECTIVE ACTION WHEN THE FIRING PIN DOES NOT STRIKE THE HEAD

If no indent is visible on the cartridge head, strip down the tool and check the condition and operation of parts.

- ▶ Worn or damaged firing pin (Item 16) - replace pin
- ▶ Worn or damaged cartridge chamber - tool has surpassed its expected usage - we recommend the purchase of a new stunning tool
- ▶ Test the tool after every corrective action to ensure the tool is working correctly before putting back into operation

TRAPPED OR STUCK CARTRIDGE REMOVAL

To remove a cartridge that is stuck and will not eject using the extractor:

- 1 Unscrew and remove the barrel (Item 1) from the tool
- 2 Remove the washers, sleeves and bolt (Items 2, 3, 4 and 7)
- 3 Grip the breech in a soft jawed vice
- 4 Using a push rod of 3/16" (4.5mm) diameter, insert into the breech and gently push out the cartridge through the cartridge chamber
- 5 Reassemble using reverse procedure to above
- 6 Clean the cartridge chamber with the chamber brush and mop as detailed in Section 8 of this instruction manual
- 7 If the tool misfires a second time, remove it from the work area as it requires further investigative work and servicing



DO NOT ATTEMPT TO USE THIS STUNNING TOOL UNTIL YOU HAVE READ AND UNDERSTOOD THESE INSTRUCTIONS.



ONLY PERSONNEL WHO HAVE BEEN AUTHORISED TO DO SO SHOULD CONDUCT ANY RECTIFICATION IDENTIFIED IN THIS SECTION



ALWAYS WEAR THE CORRECT PERSONAL PROTECTIVE EQUIPMENT (PPE) WHENEVER YOU ARE WORKING WITH, CLEANING OR MAINTAINING YOUR CASH MAGNUM AUTO TOOL. ALWAYS WEAR PROTECTIVE GLASSES AND HEARING PROTECTION. THE CORRECT FOOT PROTECTION MUST BE WORN. THERE IS A RISK THAT IF THE TOOL IS DROPPED, THE BOLT MAY PENETRATE THE FOOT OF THE TOOL USER.



ALWAYS POINT THE TOOL AWAY FROM YOUR BODY AND AWAY FROM ANY OTHER PERSON IN THE VICINITY WHEN HANDLING OR OPERATING THE TOOL

TO DIS-ASSEMBLE STOP FIRE MECHANISM (ITEM 15A)

- 1 Turn clockwise to fire (RED DOT) position and drive stop pin (Item 15) down through cap inner (Item 12) with a pin punch.
- 2 Then unscrew Stop Fire Cap (Item 14) anti-clockwise to remove.
- 3 Clean with pistol oil and brass brush end of cleaning tool.
- 4 Inspect for cracks or stripped threads and replace if found.
- 5 Replace 'O' ring (Item 13) if broken or frayed.

RE-ASSEMBLY OF STOP FIRE MECHANISM

- 1 Lightly oil or grease threads with Copaslip.
- 2 Align the small dimple on the end face of the cap inner with the cut out in the lower edge of the Stop Fire Cap - this will ensure that the 3 start thread commences location in the correct position, so that when screwed together clockwise, the cut out on Stop Fire Cap aligns precisely with the "RED DOT" mark on the inner cap, which should be fully visible.
- 3 Insert stop pin and drive flush with top of Stop Fire Cap (if pin is driven too far, the assembly will not turn).
- 4 Re-assemble onto firing pin assembly and screw down tight on breech cap, using wrench on flats of cap inner.
- 5 If Stop Fire Cap is used to screw or unscrew Stop Fire Assembly from breech cap, you will break the stop pin.

ONLY EVER USE GENUINE ACCLES & SHELVOKE REPLACEMENT PARTS. NOT USING GENUINE PARTS MAY LEAD TO PREMATURE COMPONENT AND TOOL FAILURE, WHICH COULD ENDANGER THE OPERATOR AND THOSE IN THE IMMEDIATE VICINITY. IT WILL ALSO INVALIDATE OUR ORIGINAL EQUIPMENT WARRANTY.

ACCLES & SHELVOKE WILL ACCEPT NO LIABILITY IF ANY COMPONENTS OTHER THAN THOSE SUPPLIED BY ACCLES & SHELVOKE ARE USED WITH OUR ORIGINAL EQUIPMENT. THE RESULTANT LIABILITY WILL BE WITH THE END USER OR THE DISTRIBUTOR WHO SUPPLIED THE UNAPPROVED REPLACEMENT PARTS.

Accles & Shelvoke provide a comprehensive service and repair facility where customers can have their CASH stunner serviced by our highly experienced and trained engineers. This service is generally open to UK customers. Overseas customers are advised to contact their local distributor.

- ▶ A quotation will be provided on inspection of the return of the tool, itemising service charges and replacement parts required.
- ▶ The service involves the tool being stripped, cleaned and reassembled with the replacement parts quoted to return the tool back to good working order.

Customers are advised to contact Accles & Shelvoke direct on +44(0)121 313 3564 to make arrangements to return the tool for service and repair.

CASH® Magnum Auto SPARE PARTS LIST AND DIAGRAM

ONLY EVER USE GENUINE ACCLES & SHELVOKE REPLACEMENT PARTS. NOT USING GENUINE PARTS MAY LEAD TO PREMATURE COMPONENT AND TOOL FAILURE, WHICH COULD ENDANGER THE OPERATOR AND THOSE IN THE IMMEDIATE VICINITY. IT WILL ALSO INVALIDATE OUR ORIGINAL EQUIPMENT WARRANTY.

ACCLES & SHELVOKE WILL ACCEPT NO LIABILITY IF ANY COMPONENTS OTHER THAN THOSE SUPPLIED BY ACCLES & SHELVOKE ARE USED WITH OUR ORIGINAL EQUIPMENT. THE RESULTANT LIABILITY WILL BE WITH THE END USER OR THE DISTRIBUTOR WHO SUPPLIED THE UNAPPROVED REPLACEMENT PARTS.

Fig. 11.01

©2016 Accles & Shelvoke

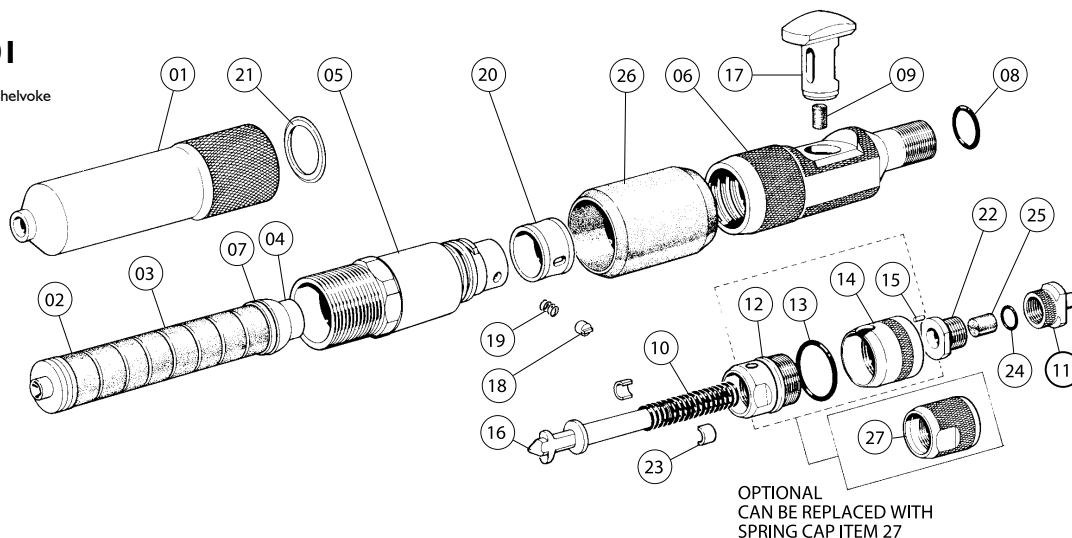

SPARE PART ITEM NUMBER	PART DESCRIPTION	QTY PER SET	SPARE PARTS BY PRODUCT CODE			
			.22" CALIBRE		.25" CALIBRE	
			5652AS	5652R	5660	5660S
1	Barrel	1	5723		5727	
2	Stop Washer	3	5369			
3	Recuperator Sleeve	8	5376			
4	Bolt	1	5684			
5	Breech	1	5724R		5734R	
6	Breech Cap	1	5725		5707	
7	Flange Washer	1	5403			
8	Small 'O' Ring	1	5627			
9	Trigger Spring	1	5628			
10	Firing Pin Spring	1	5755			
11	Pull	1	5702			
12	Cap Inner	1	5693			
13	'O' Ring	1	5695			
14	Stop Fire Cap	1	5692			
15	Stop Pin	1	3036			
15A	Stop Fire Assembly (complete)	1	5691			
16	Firing Pin	1	5698		5690	
17	Trigger	1	5689			
18	Extractor Plunger	1	5636			
19	Plunger Spring	1	5637			
20	Extractor	1	565 IR		5638	
21	Lock Washer	1	5639			
22	Pull Bush	1	5640			
23	Pull Split Bush (Pair)	1	5641			
24	Pull Lock 'O' Ring	1	5642			
25	Rubber Pull Spring	1	5710			
26	Breech Locking Cover	1	5664			
27	Spring Cap	1	5696			

CONTACT DETAILS, WARRANTY AND RECYCLING

Contact us today to find out how Accles & Shelvoke can help your current or future stunning requirements.

For customers based in Canada and USA:-

Accles & Shelvoke, 773 Victory Highway, West Greenwich, Rhode Island 02817, USA.

Website: www.accles-shelvoke.com Email: info@accles-shelvoke.com

Telephone: (1)-800-396-9497 Fax: (1)-401-397-5031

For all other customers:-

Accles & Shelvoke Ltd, Unit 5A, Maybrook Road, Maybrook Business Park,
Minworth, Sutton Coldfield, Birmingham, West Midlands, UK B76 1AL

Website: www.acclesandshelvoke.co.uk Email: info@acclesandshelvoke.co.uk

Telephone: +44 (0)121 313 3564 Fax: +44 (0)121 313 0282

WARRANTY

The Accles & Shelvoke product warranty policy is available upon request. The product warranty policy, like any other, is conditional.

Your tool has been assembled, tested and proof-stamped as a mark of its performance, quality and safety, and arrives with you in full working order.

Your CASH Magnum Auto tool has been designed and developed over years of experience in the meat processing industry. It has proven to be a very reliable and robust tool if cleaned and maintained in accordance with this instruction manual.

In the event of any problems, please contact your local distributor.

RECYCLING

Once any component or tool has surpassed its useful life, it needs to be disposed of in a responsible manner. Most of the materials from which the Accles & Shelvoke range of stunning tools is manufactured can be recycled.

These materials must be correctly separated before they can be recycled. To do so, disassemble the tool, and sort into the groups highlighted in the table below. Use the spares list and diagram (Section 11) to help with identification.

The disassembled and sorted items may be disposed of at an appropriate recycling facility.

ITEMS / PARTS	MAIN MATERIAL	DISPOSAL
All components itemised in the 'Spare Parts List and Diagram' except those detailed below	Steel	Ferrous Metal Recycling
2, 3, 7, 8, 9, 13, 19, 21, 24, 25, 26	Rubber	General Waste
Spent Cartridges	Brass	Non-ferrous Metal Recycling
Packaging - Cardboard	Cardboard	Cardboard recycling
Packaging - Plastic	Plastic	Plastics recycling
Other non-specified items	Various	General Waste

DECLARATION OF CONFORMITY



**accles
& SHELVOKE**[®]
Since 1913

Manufacturer name:	Accles & Shelvoke		Machinery covered by this declaration	
Full address:	Unit 5A, Maybrook Road, Maybrook Business Park, Minworth, Sutton Coldfield, Birmingham, West Midlands, UK B76 1AL		Description:	CASH Magnum Auto range of captive stunning tools
			Function:	For the stunning of livestock prior to slaughter or depopulation
			Product Code of stunner supplied with instruction manual	NOTE APPLY MODEL NUMBER & MODEL DESCRIPTION LABEL HERE
Product Description				
Full list of products declared under this Certificate Number:	5652AS	CASH Magnum .22R Auto SF	Serial number:	NOTE APPLY SERIAL NUMBER LABEL HERE
	5652R	CASH Magnum .22R Auto		
	5652RF	CASH Magnum .22R Auto		
	5653	CASH Magnum .25R Auto		
	5660	CASH Magnum .25R Auto		
	5660S	CASH Magnum .25R Auto SF		

The machinery conforms to all the requirements of the Machinery Directive 2006/42/EC

The machinery also conforms to the following Directives and UK Laws:	EU Council Regulation (EC) No 1099/2009 on the protection of animals at the time of killing; The Gun Barrel Proof Act 1978;
---	--

The following standards have been used:	EN ISO 12100:2010
--	-------------------

Notified body who carried out the EC type examination or Full Quality Assurance :	Name:		
	Address:	amtri veritas ltd, veritas house, pierce street, macclesfield sk11 6er	
	Notified body No. :	0463	Certificate No.: AVEC 3847-3

The technical file is compiled in accordance with part A of Annex VII of the Machinery Directive 2006/42/EC

Person authorised to compile the technical file (based in the European Community):	Name:	Steve West - Manufacturing Manager
	Address:	Refer to company address above

The relevant authorised person undertakes to transmit, in response to a reasoned request by the national authorities, relevant information on the machinery. This information will be transmitted by: e-mail

Person authorised to make this declaration:	Name:	Joe Holland
	Position in company:	General Manager
	Signature:	
	Place of declaration:	Unit 5A, Maybrook Road, Maybrook Business Park, Minworth Sutton Coldfield, Birmingham, West Midlands, UK B76 1AL
	Date of declaration:	1 st May 2017